

# CL5200 SERIES | Anyshop Scale



## SPECIFICATIONS

Model	CL5200		
Max.capacity(kg)	3/6	6/15	15/30
Readability(g)	1/2	2/5	5/10
External resolution	1/3,000(dual interval)		
Display type	Graphic LCD(208 x 48)		
Printing speed	Max. 100 mm/sec		
Printer resolution	202 dpi		
Label size (mm)	Width:40~60, Length:30~120		
Power	AC 100~240V, 50/60 Hz		
Operating temperature	-10°C ~ +40°C		
Platter size (mm)	B,P Type:380(W) x 250(D)		
Dimensions(mm)	B Type:409(W) x 441(D) x 180(H) P Type:410(W) x 500(D) x 535.8(H)		
Product weight(kg)	B Type:6.95, P Type:7.65		

## FEATURES

- Memory capacity: 10,000 PLUs & 1,000 ingredients
- Supporting free label format design
- Cartridge-loading-type label installation
- 45 fixed format & 20 customized format design
- Various interface
- Combined wide LCD display

## OPTION

- Wireless bridge card
- PC manager program(CL-Works)
- Platter with back rail

## DIMENSIONS

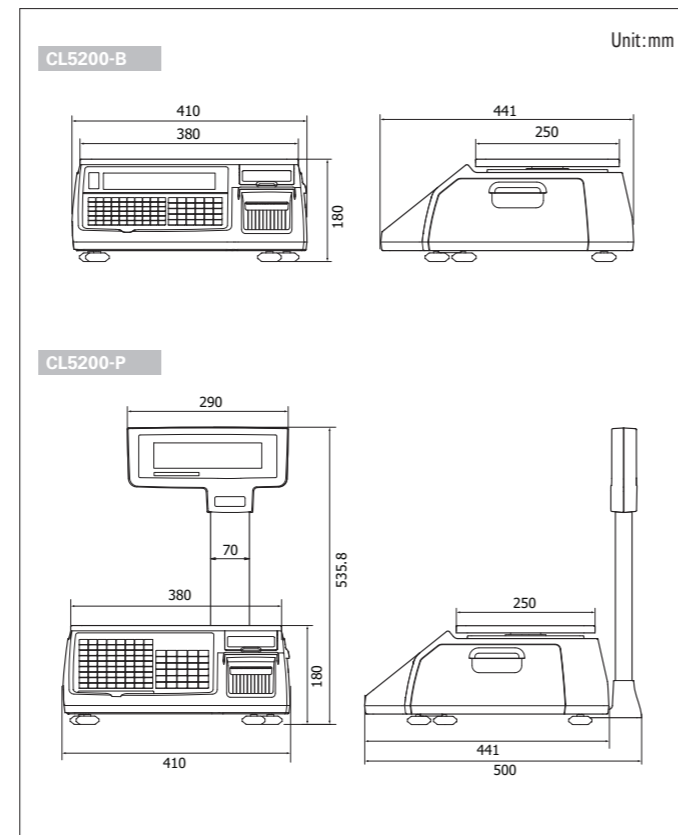

## RETAIL WEIGHING SOLUTION™



Large LCD display



Easy loading Paper Cartridge



Direct PLU keys & function keys

# CL5200 SERIES

## It's a must-have scale for your shop!!

- Flexible & reliable network system (wired/wireless)
- Easy loading paper cartridge
- Free format label design
- User friendly PC software



CAS BLDG., # 440-1, SUNGNAE-DONG,  
GANGDONG-GU, SEOUL, KOREA  
TEL\_ 82 2 2225 3500  
FAX\_ 82 2 475 4668  
<http://www.globalcas.com>

Specifications are subject to change for improvement without prior notice.



Plot No. 788, Udyog Vihar, Phase V  
Gurgaon-122016 (HR)  
Tel : +91-124-234 2621/3/4, 401 1651/2/3  
Tel : +91-124-492 2800-49  
Fax : +91-124-234 2626

C-72802102

# CL5200 SERIES

TOTAL WEIGHING SOLUTION™

## Hardware

### Steady PLU keys

The embossing membrane keypad adds a steady look of CL5200-P and CL5200-B. Double-click function provides easy access to the key's secondary PLU, totaling in double of PLU key numbers.



### Large display

Large full graphic LCD display is suitable for any environment. (208x48 dot graphic LCD).  
- Tare/Weigh/Unit/Price : 4/5/6/6 digits



### High speed printer

High speed thermal printer supports label/ticket printing. Guaranteed satisfaction with 100mm/s speed and 202dpi resolution.



### Paper cartridge

Cartridge loading type supports quick and easy replacement of new label roll.  
- Various paper support  
- Auto measuring system

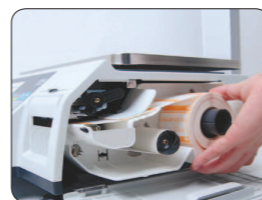

### Various interface connetions

It supports RS-232c, PS/2, Cash drawer, wired/wireless Ethernet, and USB Device.



### Menu system

No need to scroll through menus for programming settings. Unique 4 digit 'Menu Code' entry pin helps pinpoint the desired program field.  
ex) Menu code '1120' is for editing PLU name.

## PRODUCT LINE UP

- CL5200 is compatible with all CAS label printing scales in the same network
- Combined wide LCD looks better

### CL5500 LINE UP



▶ CL5500-B



▶ CL5500-P



▶ CL5500-R



▶ CL5500-H



▶ CL5500-S



CL5200-B



CL5200-P

## Software

### Label Formats

There are 45 preset labels installed in the scale and additional 20 formats can be modified freely with CL-Works PC program.

- Continuous label/ticket
- Up to 120mm label length

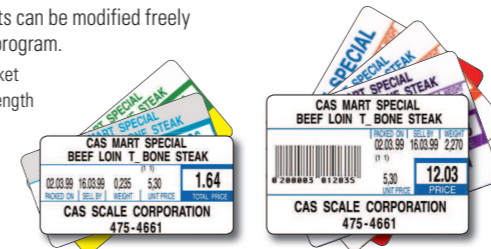

### Barcode

Almost every conventional 1-Dimensional barcode types are available.

- UPC, EAN13, EAN13A5, I2OF5, CODE128, CODE39, CODE93, CODABAR, IATA20F5



## Network System

- TCP/IP communication protocol
- IEEE802.11g specification wireless network
- Wireless security : WEP 64/128, WPA, WPA2
- One to one & multi to multi & wired/wireless network
- Network structure for
  - Large, medium and small independent markets
  - Pre-pack and self-service counter
  - Hyper market

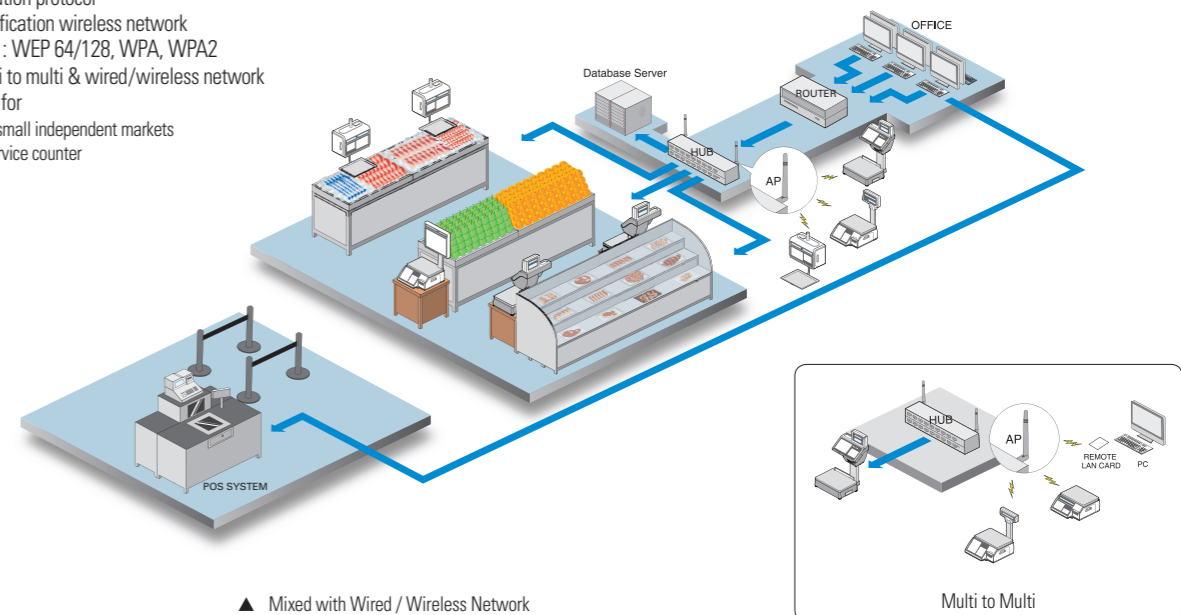

## PC software:CL-Works

CL5200 supports PLU programming, store data, sales report, label editor and much more.

You can control all the program data by CL-Works. CL5000, CL5000J and CL5500 share this software with CL5200.

### CL-Works

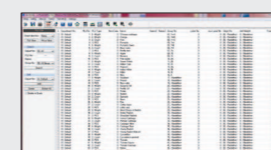

#### PLU Editor

- Enable easy control, of PLU
- Allows PLUs management by excel

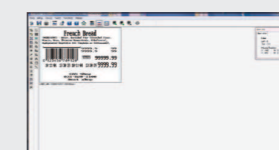

#### Label Editor

- 20 modifiable label formats
- Easy downloading of label formats

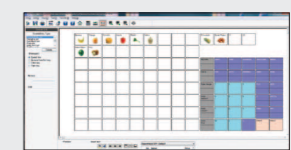

#### Keypad Editor

- Easy to setup and download
- Key design color image
- Keypad supported